

Open corner / assembly instruction

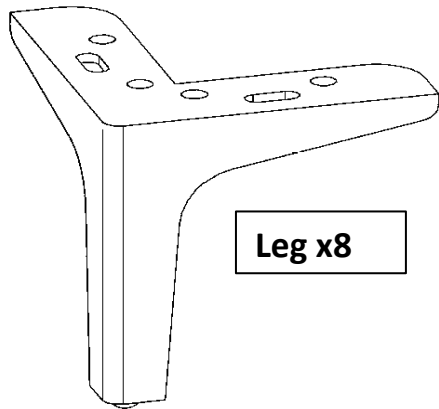

Leg x8

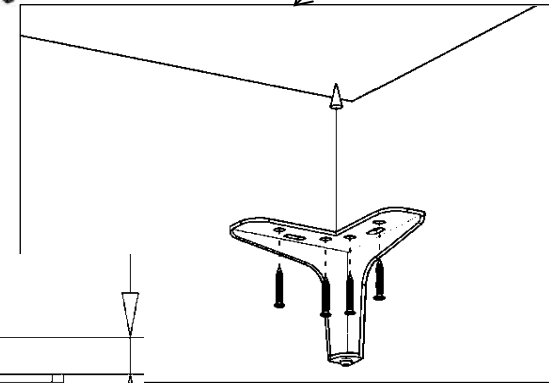
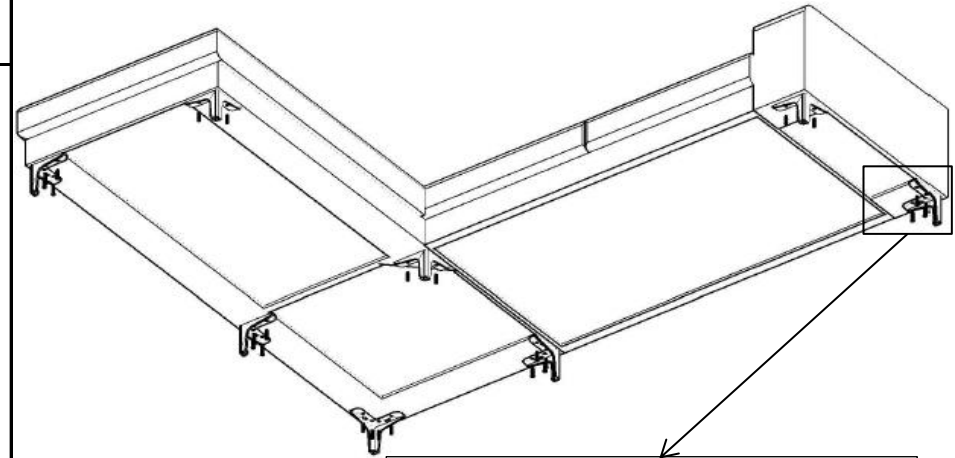
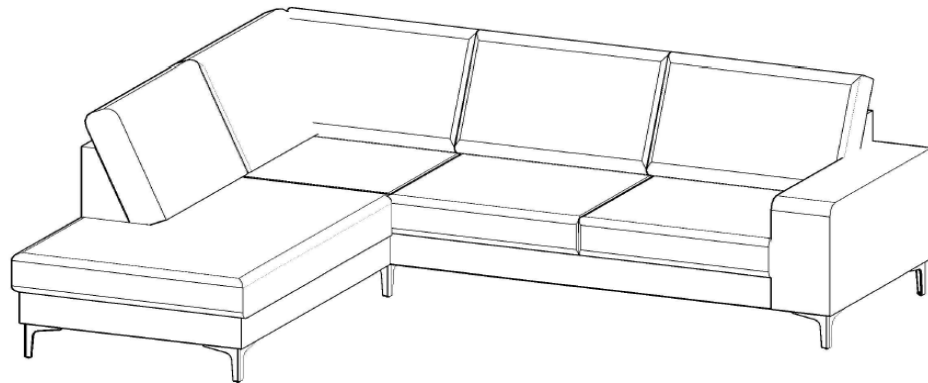

(5x30) x32

